

## THE DETECTION OF PILOT-INDUCED OSCILLATIONS

**P. Rzucidło**

*Rzeszów University of Technology, Department of Avionics and Control, ul. W. Pola 2, 35-959 Rzeszów, Poland*

*E-mail: pawelrz@prz.edu.pl*

*Received 2006-10-26, accepted 2007-03-20*



**Paweł RZUCIDŁO**, PhD. Eng.

*Education:* M.Sc. (Eng.) degree in Aeronautics, Rzeszów University of Technology, Faculty of Mechanical Engineering and Aeronautics. 2001 to 2005: PhD. studies, Rzeszów University of Technology, Faculty of Mechanical Engineering and Aeronautics, *Specialization:* Machine Building and Exploitation.

*Research interest:* Aircraft Control with an Emphasis on Interactions Between Human and Machine.

*Publications:* Author or coauthor of 5 scientific articles, 15 conferences papers and reports.

*Present position:* 2005 to present: Researcher, Rzeszów University of Technology, Department of Avionics and Control.

**Abstract.** Fly-by-wire systems enable superior control of chosen flight parameters. A pilot can modify stabilized parameters by adequate movement of control inceptors such as a side-stick or trust lever. Fly-by-wire control reduces the load on a pilot and allows a pilot to focus on the main tasks. Unfortunately, the use of more complicated interfaces between human and machine can cause incorrect pilot behavior and in many cases lead to erroneous interactions between the operator and effective aircraft dynamics. The structure of control laws and dynamics of electromechanical actuators are especially important factors. They can influence unfavorable aircraft-pilot coupling and can lead to pilot-induced oscillations (PIO) in certain cases. The automatic detection of PIOs is presented in this paper. The practical realization of a PIO-detector and examples of diagnostics of human-machine systems are reported on in this article.

**Keywords:** pilot-induced oscillations, PIO, detector, fly-by-wire.

### Introduction

Indirect flight control technology extends aircraft control possibilities, stabilizes flight parameters, and enables more flexible automatic control. With a fly-by-wire (FBW) control system, a pilot can work as a computer operator or he can control the plane classically by using the control wheel or side stick in standard mode. The principle of an FBW system is converting pilot activity to electrical signals (in fly-by-light systems, fiber optics replaces electric wires). These signals are sent to flight computers (Fig 1). They calculate the desired positions of control surfaces and provide digital signals to actuators where discrete information is changed to control surface movement [1]. This process is performed without direct mechanical connections between the control lever and control surfaces.

In the beginning, FBW systems helped overcome problems with conventional systems (for example the Concorde) or they were experimental installations. The first digital FBW was used on F-8 Crusader aircraft and later they were used in the Space Shuttle program, where automatic augmentation was necessary. Indirect flight control technology has been applied in military and large

transportation aircraft for the past 15 years. The next natural step seems to be using these systems in general aviation and even in small general aviation aircraft.

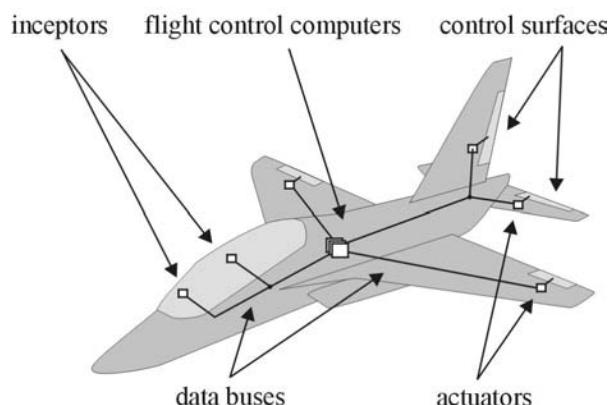

**Fig 1.** Principles of Fly-by-Wire

### SPS-1A system

The SPS-1A indirect flight control system for small aircraft has been designed at the Department of Avionics

and Control at Rzeszów University of Technology (Fig 2) [6, 7]. This system consists of three flight computers connected with measurement units and inceptors through three CAN (control area network) data buses. Low speed CAN buses are used for communication between flight control computers and control surface actuators. The SPS-1A system can operate in direct, CAS (control augmentation system), and SAS (stability augmentation system) modes. The third mode gives a pilot superior and easy control of chosen flight parameters and has great influence on handling qualities. It improves the safety of flight and minimizes pilot load. Unfortunately, there are possible situations in which the pilot feels motion cues abnormally. In a mechanical control system, deflection of a lever is strictly connected with consequent control surface deflection, but in FBW this is not the case at all. Pilots of aircraft equipped with indirect flight control systems should be aware of this property. The movement of the control lever directly influences flight parameters (not the displacement of aerodynamic surfaces).

### **Pilot-induced oscillations**

The term pilot-induced oscillations (PIO) suggest that pilot behavior is responsible for this undesirable phenomenon. This is not true. An indirect flight control system can improve aircraft dynamics but it can also destabilize the airframe after certain unexpected events. How is this possible?

Signals received from inceptors are usually modified in indirect flight control system. Special shaping functions are used for this purpose. They take static position as well as direction and speed of control lever or side-stick movement into account. Shaping functions allow for fast and efficient correction of flight parameters in an open-loop system and in effect minimize pilot activity. Vibrations of the lever or side-stick are also filtered. Flight control computers process signals delivered from inceptors and measurement units. Desired positions of control surfaces are calculated depending on inceptor movements, values of flight parameters, and the chosen flight mode. Then actuators move aerodynamic surfaces and position thrust lever. Control laws implemented in flight control computers are responsible for stabilization of flight parameters (e.g. pitch and roll angles). Inner feedback loops are closed by software but outer feedback loops (e.g. changes of pitch and roll) closed pilot. Output to input delays are an important factor in the fly-by-wire system. A serious problem is reduction of time delay caused by measurement units (air data computers, attitude heading reference systems) and data buses and software computations (e.g. filters). Time delay may vary for different sizes or frequencies of inputs. The delayed reaction of the aircraft should be considered during the early design process. In fact the effective time delay of the aircraft should not exceed 0.1 s for very good handling qualities and 0.25 s for safety reasons. Another problem observed in a number of accidents is the actuator rate limit. It can cause loss of control and occurs when the actuator input function is faster than the capabilities of the electromechanical unit.

Improvement of a flight control system equipped with actuators that are too slow is practically impossible. Another factor is the complexity of control laws and possibility of flying in different modes. Analysis of many aspects of pilot-aircraft interactions is very hard, laborious and problematic. A lot of problems are not recognized on time and some problems can appear during tests and even during normal exploitation of aircraft.

An unfavorable aircraft-pilot coupling can be defined as an inadvertent, potentially dangerous closed-loop phenomenon between the pilot and the aircraft response [8]. It can lead to a divergent action or cause sustained oscillations in the flight path or/and attitude. This phenomenon is known as pilot-induced oscillations (PIO). Frequencies of severe PIO are in the range of 2–5 rad/s. They are characterized by pilot inputs that are shifted 180 degrees in phase compared to aircraft response. They can develop into large magnitude oscillations and can destroy aircraft. The pilot sustains oscillations even though he is trying to stop them because he feels that the aircraft is not responding to his input correctly [8].

PIO can take many forms and just about every new aircraft design ever flown has experienced some form of PIO at some time. Most such events are minor in magnitude, easily rectified, and never reported in literature [4]. The original 1903 Wright Flyer was susceptible to pilot-induced oscillations, and after 103 years this problem still seems to be unpredictable (accidents of JAS39, YF22, A320, B777, and others).

### **Algorithms of PIO detection**

In the past few years some research has led to the development of automatic detectors of pilot-induced oscillations. Authors of work [5] presented a real-time PIO detector based on probabilistic neural networks. The main harmonics of pitch (roll) oscillations, control lever movements, and phase lag between aircraft response and pilot activity are used as the inputs of the neural network. An additional input is the rate saturation marker of the elevator (aileron) actuator. This enables the determination of PIO category (I – linear or II – quasi linear, under rate saturation).

Another solution utilizes fuzzy logic for detection of inadvertent aircraft-pilot coupling [2] but its main rules are similar to the idea presented in work [5]. Paper [4] contains the widest description of methods of PIO detection. The authors established the following general rules that should be considered during determination of pilot-induced oscillations:

- assume every aircraft response is an oscillation,
- limit the search to a reasonable frequency range,
- focus on aircraft response, then look for a corresponding control input,
- check for phase differences between aircraft response and pilot input (phase lag near 180° is characteristic for PIO events),
- check the amplitudes of peak angular rate and cockpit control inputs (to distinguish small oscillatory

disturbances and significant aircraft-pilot coupling events),

– use an easily monitored aircraft state (analyze pitch rate response rather than pitch angle).

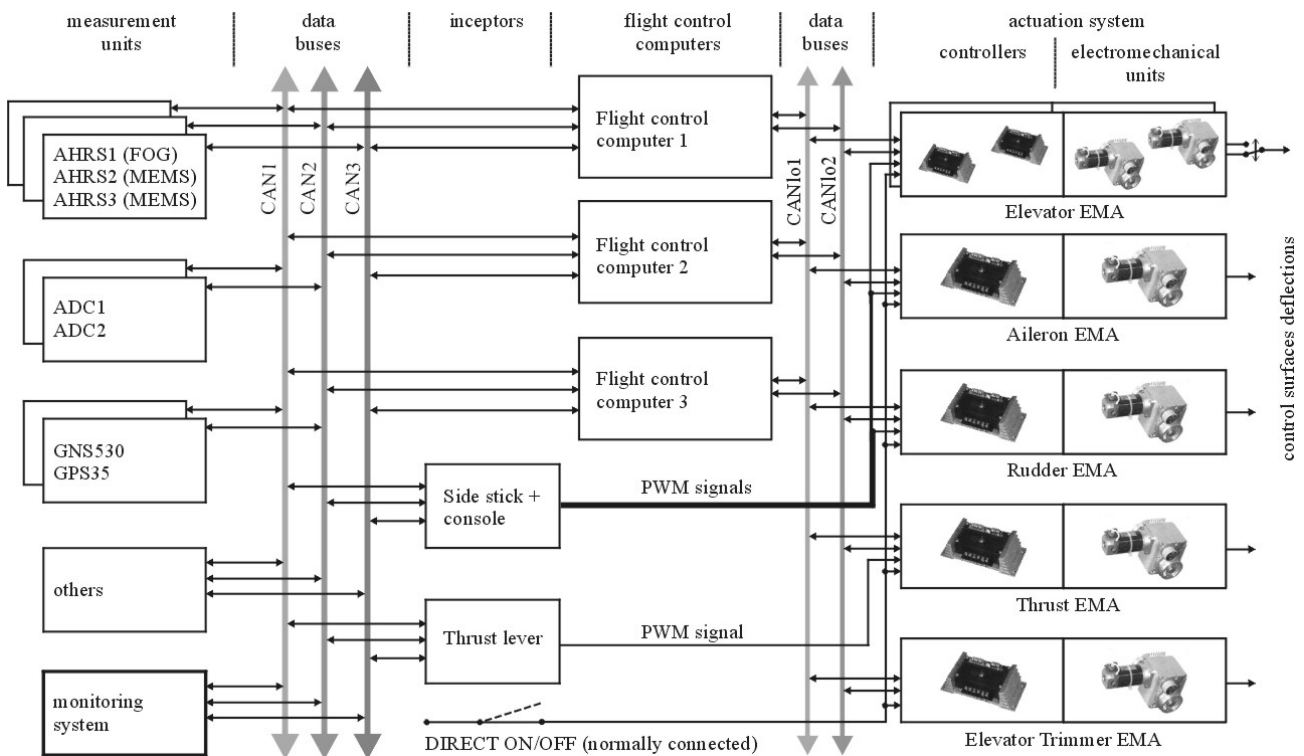

Fig 2. Block scheme of experimental SPS-1A indirect flight control system

All these points are clear and obvious, but a short comment is needed for the last one. The medium value of rate response is approximately zero in relatively small periods of time, and it is much easier to analyze pitch rate than pitch angle response. Moreover, rate response is faster than angular response (90 degrees phase lead) and is much easier to measure. A PIO detector based on rate analysis is characterized by better dynamics. This factor is especially important in real-time applications. Phase lag between input and rate-type output is near 90° during PIO.

The rules and ideas presented above were applied to the PIO detection algorithms presented in this work. The detector was designed for the detection of pilot-induced oscillations in longitudinal motion of PZL-110 “Koliber” aircraft. Algorithms use the fast Fourier transforms (FFT) for preliminary analysis<sup>\*)</sup>. Data are computed in frames. The length of the frame is equal to the length of the FFT window. The frame slides from the beginning to the end of the data with a constant step. Presented detection algorithm (Fig 3) was applied for data recorded with a 0.01 s sampling time. The data frame was limited to 5 s (to obtain harmonic above 1 rad/s at established sampling time). The small step of the sliding window allows precise analysis of data, but on the other hand, the time of computations is excided in this case. For practical purposes 1/10 of the FFT window length was set as a step.

The block scheme of PIO detection algorithms is presented in figure 3. At first the FFT window is placed at data start. FFT analysis of input and output data is done next. Analysis of pitch rate or pitch response is possible. Elevator actuator rate  $R$  is estimated as a parallel task. Harmonic with maximal amplitude or harmonic with minimal phase lag between input and output is established as oscillation frequency (dependent on version of algorithm selected by user). Then amplitude  $A$  and phase lag  $\Delta\phi$  of the main frequency are calculated. After this  $A$  and  $\Delta\phi$  are compared with threshold values ( $A_g=7.5^\circ$ ,  $\Delta\phi_g=-150^\circ$  for pitch and  $A_g=3$  deg/s,  $\Delta\phi_g=-60^\circ$  for pitch rate). If at least one condition is negative, the next window is analyzed. PIO are detected when both conditions are completed. Additionally,  $R$  is compared with the predicted elevator rate saturation value. If this condition is true, quasi-linear PIO (category II) are possible. Otherwise linear phenomenon (category I) is predicted.

A cluster of points obtained on a time chart (example in figure 4) can be interpreted as the occurrence of PIO. A cluster indicates sustained oscillations, and a single point shows a short, temporary disturbance only.

<sup>\*)</sup> RZUCIDLO, P. Methods of suppression of pilot induced oscillations in fly-by-wire aircraft. PhD Thesis. Rzeszow University of Technology, Rzeszow, 2005.

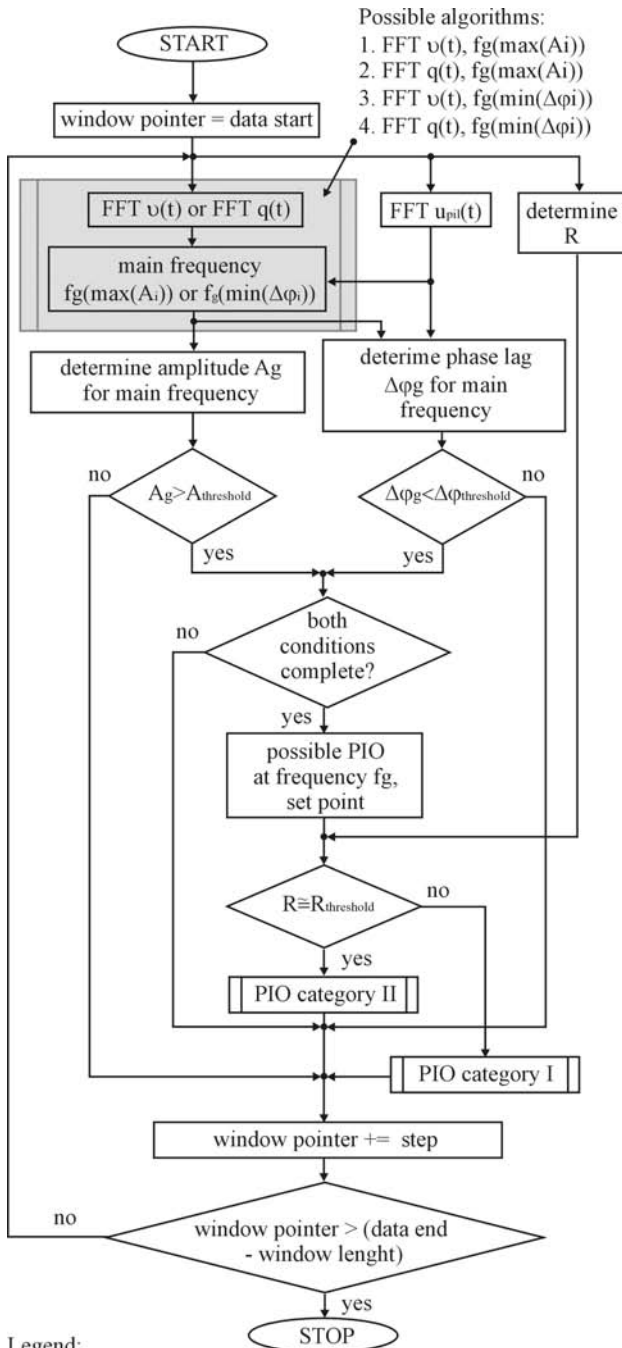

Legend:  
 $v$  - pitch angle,  
 $q$  - pitch rate,  
 $upil$  - control lever deflection,  
 $R$  - rate saturation of elevator servo,  
 $f$  - frequency,  
 $A$  - amplitude,  
 $i$  - number of harmonic frequency component,  
 $\Delta\phi$  - phase difference.

Fig 3. Proposed algorithms of PIO detection

### Verification of PIO detection algorithms

PIO detection algorithms were implemented in the Matlab environment as functions <sup>\*)</sup>. They were verified

<sup>\*)</sup> RZUCIDLO, P. Methods of suppression of pilot induced oscillations in fly-by-wire aircraft. PhD Thesis. Rzeszow University of Technology, Rzeszow, 2005.

with data sets obtained during computer simulations, pilot-in-the loop, and in-flight tests. A comparison showed that the effectiveness of certain algorithms is different. Algorithms based on the estimation of maximal amplitude harmonic were too sensitive for slow oscillations (about 1 rad/s), and a lot of clusters were incorrectly localized in effect. Detectors based on the estimation of harmonic with a minimal phase lag between input and output appeared to be more accurate because many localized clusters were connected with PIO. They were too sensitive at high frequencies. The best during off-line tests was a detector based on the estimation of harmonic with a minimal phase lag that analyzed pitch angle between input and output.

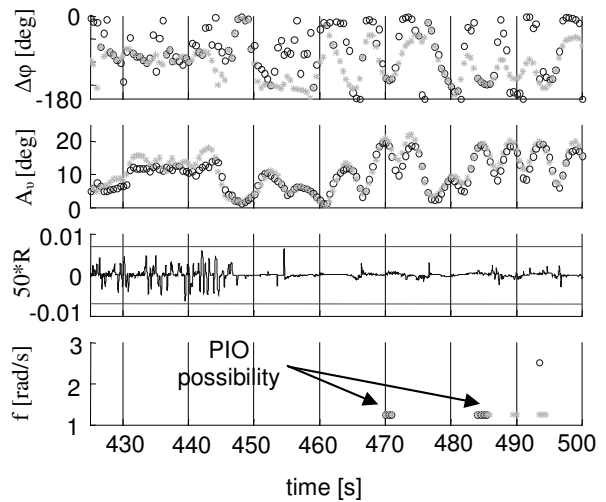

Fig 4. Example of PIO identification (FFT analysis of pitch angle)

$\Delta\phi$  — phase lag between main frequency of pitch angle and main frequency of control lever output [deg],  
 $A_v$  — amplitude of main frequency of pitch angle [deg],  
 $R$  — elevator positioning rate [rad/s],  
 $f$  — frequency of oscillations in pilot-aircraft system [rad/s].

Figure 4 presents an example of PIO detection. Time charts were recorded during simulated flight (27.06.2005, pilot OS, time of flight about 20 minutes), and the detector showed distinct localization of the PIO phenomenon. Limitation of the search area to the time period between 425 s and 500 s enabled the precise localization of oscillations. They were featured by phase lag over 150 deg. Amplitude of pitch angle oscillations excided  $10^\circ$  at frequencies 0.7 rad/s (Fig 5).

### Pilot-in-the loop simulations

Experiments with the participation of pilots were done at a special laboratory stand. A simplified flight simulator was designed and built especially for PIO test purposes. This was necessary because there was no technical or formal possibility to modify a typical simulator used for pilot training. Experimental mini flight

simulator bases on real-time model of PZL-110 “Koliber” aircraft dynamics. D Space rapid prototyping environment complete with Matlab/Simulink software was used for preparation of the core of this simulator. This solution enables the coupling of chosen SPS-1A indirect flight control system components and the simulator core (Fig 6). They communicate through a CAN data bus [3].

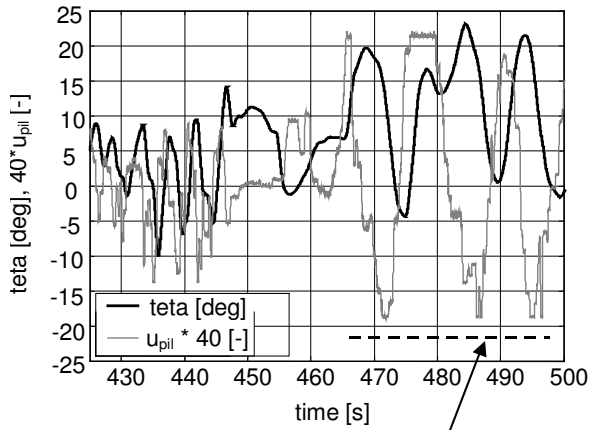

Fig 5. Phenomenon localized with the use of PIO detector (presented in figure 4)

teta — pitch angle [deg],  
 $u_{pil}$  — control lever deflection in pitch channel [-].

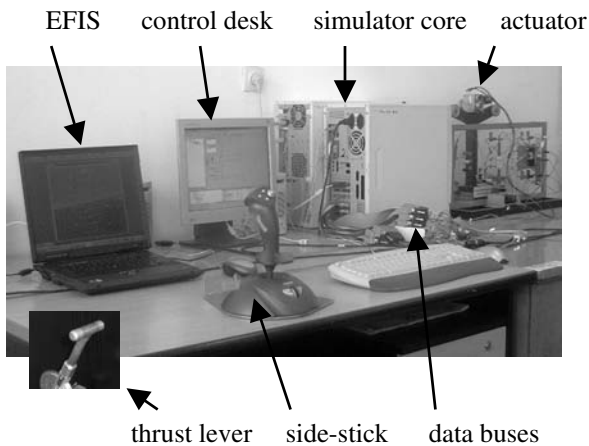

Fig 6. Block scheme of laboratory stand used for pilot-in-the loop simulations

The flight program included special maneuvers like aggressive tracking or approaching according to recommendations presented in literature [8]. The simulation was prepared to make pilots climb after starting, with simultaneous turning and tracking of complex trajectory, approaching path, etc. (Fig 7). The desired flight path was presented on an integrated indicator prepared by the author of this paper (Fig 8). The path was presented as a quadratic tunnel-in-the-sky. The width of squares was set as 40 m, and it was narrowed to 10 m at the touchdown point during landing approach.

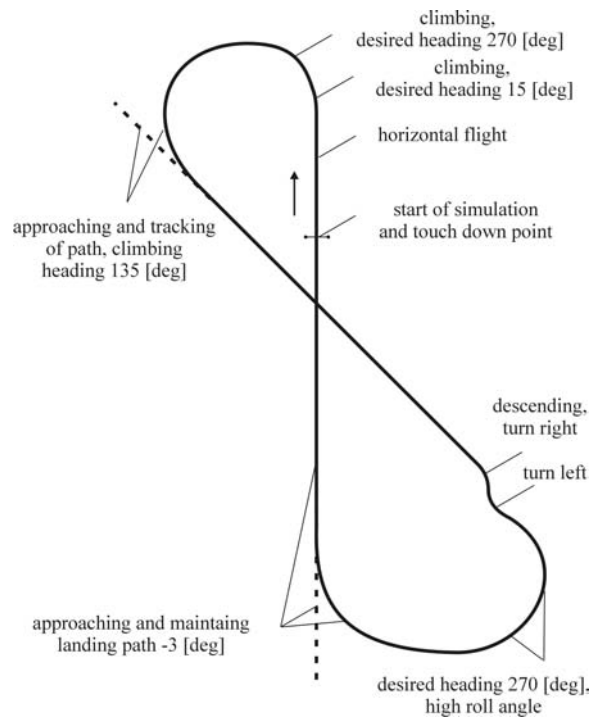

Fig 7. Horizontal view of desired flight path

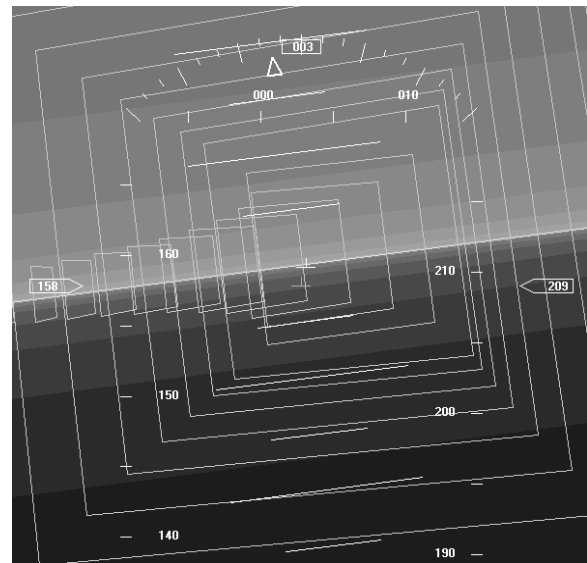

Fig 8. Desired flight path visualized as tunnel-in-the sky

Thirteen pilots took part in 65 simulated flights. One thousand three hundred minutes of experiments were recorded and collected in 416 MB of data, which include 34 chosen flight parameters, pilot activity, and control system parameters. The test participants completed special forms and gave PIO ratings to flights on a PIOR (PIO rating) scale [4].

Automatic PIO detectors also analyzed time charts obtained during simulated flights. A comparison of the evaluations made by pilots and the results of automatic PIO detection is presented in table. PIOR scale values were presented for every examined flight mode. The table also contains the number of PIO phenomena detected.

**Table.** Estimated PIO susceptibility of PZL-110 “Koliber” aircraft equipped with SPS-1A system

PIO susceptibility	PIO rating (1 — no PIO, 6 — sever PIO)			PIO detector (number of detected mild / sever PIO)		
	control mode			control mode		
	direct	SAS (pitch stabilization)	SAS (pitch rate stab.)	direct	SAS (pitch stabilization)	SAS (pitch rate stab.)
JZ	1	2	3	1/-	-/-	4/-
PZ	2	1	3	-/-	-/-	4/1
MS	2	1	3	9/-	-/-	5/-
RM	1	2	3	-/-	-/-	4/1
MW	1	1	2	3/-	-/-	8/-
PB	1	1	1	-/-	-/-	4/1
TR	2	2	2	-/-	-/-	7/1
MSz	2	1	4	2/-	-/-	10/2
JB	2	1	1	4/-	-/-	4/-
PP	3	3	3	7/-	1/-	9/-
OS	2	1	1	2/-	-/-	11/1
ŁW	1	1	1	-/-	-/-	4/-
MK	1	2	1	-/-	2/-	6/1
Rating range:	1–3	1–3	1–4	1–9/ -	1–2/ -	4–11/ 1–2
Medium values:	1.5	1.5	2.2	2.2/ 0	0.2/ 0	6.2/ 0.6

Short-term disturbances were discovered in the pilot-aircraft system in every flight mode. They can occur during normal operations in every aircraft, but a properly designed control system should enable the pilot to damp them immediately. They should not escalate in any case. Short (one period) disturbances appeared two times (pilot PP and MK) in pitch angle stabilization mode but they were quickly damped. A lot of pilots evaluated this mode as PIO free. Inadvertent oscillations never appeared or were easy to compensate. In the opinion of the pilots, the pitch rate stabilization mode was the most susceptible to PIO. Automatic detections confirmed these results (Fig 9–10).

The results obtained from the PIO detector show no PIO tendency in longitudinal motion during preliminary in-flight tests of the experimental aircraft (Fig 11–13). Only one recorded file contains significant oscillatory pilot-aircraft behavior at low frequency (Fig 14). This frequency (about 0.3 rad/s) is below the range of classical PIO. Localized phenomenon was featured by strong disturbances in aircraft pitch angle. Investigation showed that admissible loading of the elevator actuator was reached in this case and the actuator clutch was disengaged for a short period of time. Phugoidal oscillations in longitudinal motion of the PZL-110

“Koliber” aircraft appeared in consequence, but they of course cannot be classified as PIO. The disconnection of the control loop caused phase lag between pilot activity and aircraft response in this case.

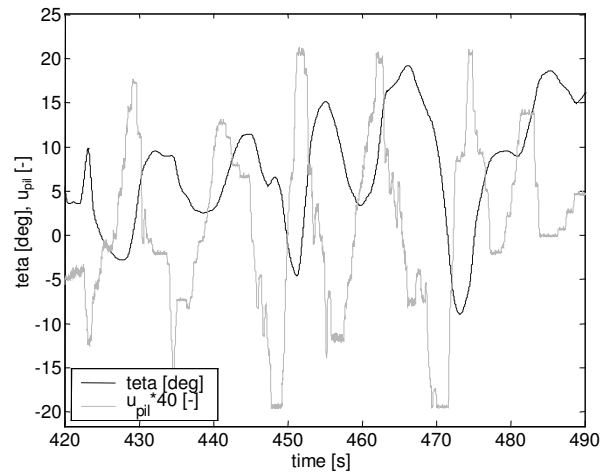

**Fig 9.** Localized and identified PIO category I sequence (flight simulator)

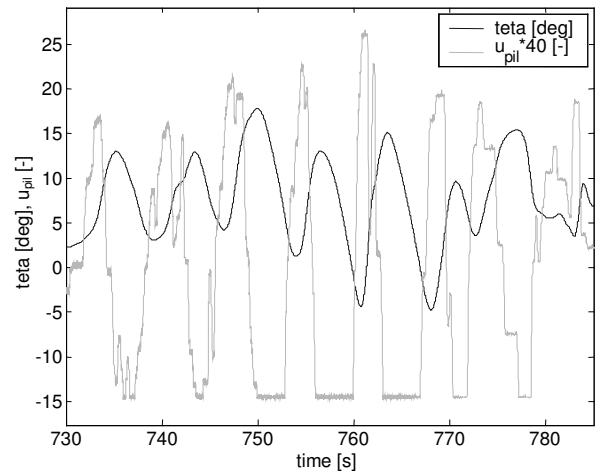

**Fig 10.** Localized and identified PIO category II sequence (flight simulator)



**Fig 11.** PZL-110 “Koliber” aircraft



Fig 12. Cockpit of PZL-110 "Koliber" experimental aircraft

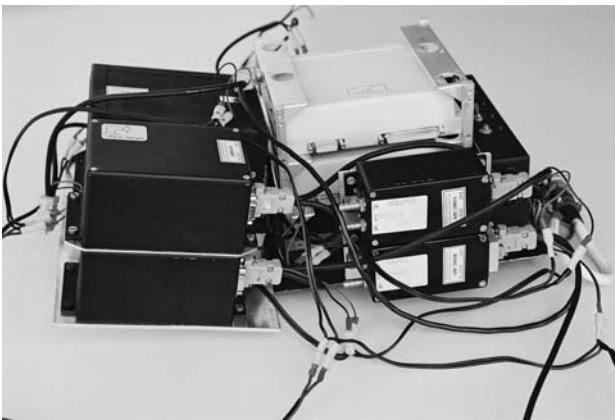

Fig 13. Core of SPS-1A system

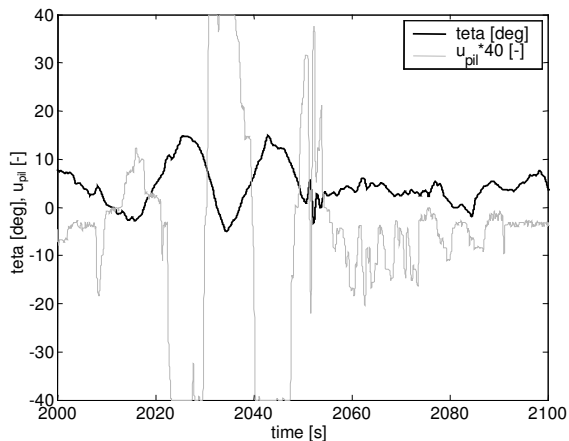

Fig 14. Oscillatory phenomena noticed during in-flight tests

## Conclusion

The pilot-induced oscillation detector that was presented has been used for automatic detection of unfavorable aircraft-pilot coupling in large sets of data. It has enabled fast and precise localization of PIOs. The PIO detector was used for preliminary analysis of data recorded during simulated and real flights of the PZL-110

"Koliber" aircraft equipped with an experimental indirect flight control system. Tests performed in flight (SPS-1: July-November 2003 and SPS-1A: August-October 2006) support the laboratory tests results in general but some particular problems were noticed and a few conclusions have been reached.

Significant pilot-induced oscillations were not observed during flight tests so far, but that does not mean that the aircraft is PIO free. The power of actuators installed on board the PZL-110 was inefficient, especially during aggressive maneuvers. An aircraft equipped with a powerful actuation system can be much more susceptible to this phenomenon in some cases (possibility of rapid maneuvers) and can be resistant to some forms of PIO on the other hand (better man-machine coupling).

The flight envelope of the experimental PZL-110 aircraft was limited because of safety. All tests were conducted in the summer and autumn, and flights were also limited because of economic reasons. It was practically impossible to test the control system under all possible flight conditions, system configurations, trigger events, and human behavior.

It can be concluded that the use of the PIO detector supports designers and allows them to recognize susceptibility to pilot-induced oscillations, but it cannot definitely help remove this risk. Proposed methods of detecting PIO seem to be helpful during analysis of data obtained from standard flight recorders. The use of automatic detection of pilot-in-the loop oscillations can improve the safety of future aircraft. Real time applications of the algorithms described can be used to warn pilots against dangerous phenomena and to suppress PIO automatically.

## References

1. GRUSZECKI, J.; GRZYBOWSKI, J.; RZUCIDŁO, P. Electro-mechanical actuators for general aviation fly-by-wire aircraft. *Aviation*, Vilnius: Technika, 2005, vol. IX, no 1, p. 19–25.
2. JERAM, JG.; PRASAD, JV. Fuzzy logic detector for pilot induced oscillation. In *American Helicopter Society 59<sup>th</sup> Annual Forum*, May 6–8, 2003, Phoenix, Arizona.
3. KOPECKI, G.; RZUCIDŁO, P. Problems of monitoring in the fly-by-wire system for small aircraft. In *AIAA 2001-6340, AIAA Guidance, Navigation and Control Conference and Exhibit*, August 21–24, 2006, Keystone, Colorado.
4. MITCHELL, DG.; ARENCIBIA, AJ.; MUNOZ, S. Real-time detection of pilot induced oscillations. In *AIAA Atmospheric Flight Mechanics Conference and Exhibit*, August 16–19, 2004, Providence, Rhode Island.
5. RAIMBAULT, N.; FABRE, P. Probabilistic neural detector of pilot induced oscillations (PIO), AIAA 2001-4353. In *AIAA Guidance, Navigation and Control Conference and Exhibit*, August 6–9, 2001, Montreal, Canada.

6. TOMCZYK, A. Experimental fly-by-wire control system for general aviation aircraft. In *AIAA-2003-5776, AIAA Guidance, Navigation and Control Conference and Exhibit*. August, 2003, Austin, Texas.
7. TOMCZYK, A. Facilitated airplane – project and preliminary in-flight experiments, *Aerospace Science and Technology* 8(2004). In [www.elsevier.com/locate/aescte](http://www.elsevier.com/locate/aescte).
8. Van der WEERD, R. Pilot-induced oscillation suppression methods and their effects on large transport aircraft handling qualities. *DUP Science*, Delft, 2000.